

FRESH-AIRE ICE UV™

Germicidal UV Light For Ice Machines Installation Instructions

Fresh-Aire Ice UV fights mold growth and bacteria in ice making machines. It extends the life of the ice machine by reducing microbial growth, lowers maintenance costs by extending the time between cleanings and results in cleaner, healthier ice.

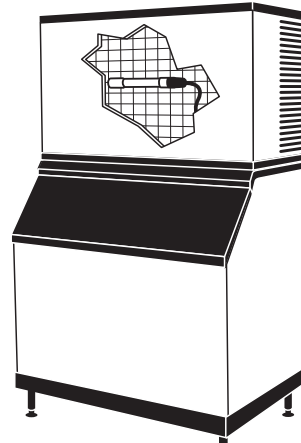

Fresh-Aire Ice UV
installed in ice machine

Parts Included

- A Ice UV Lamp
- B Lamp Shield
- C Power Supply
- D UV Warning Sticker
- E Mounting Bracket
- F Sight Glass 0.5"
- G Zip Tie Base
- H Zip Tie
- I Plastic Rivets
- J Adhesive Vinyl
- K Self-tapping screws
- L Bolts
- M Locking Nuts
- N Connectors
- O Optional Safety Interlock

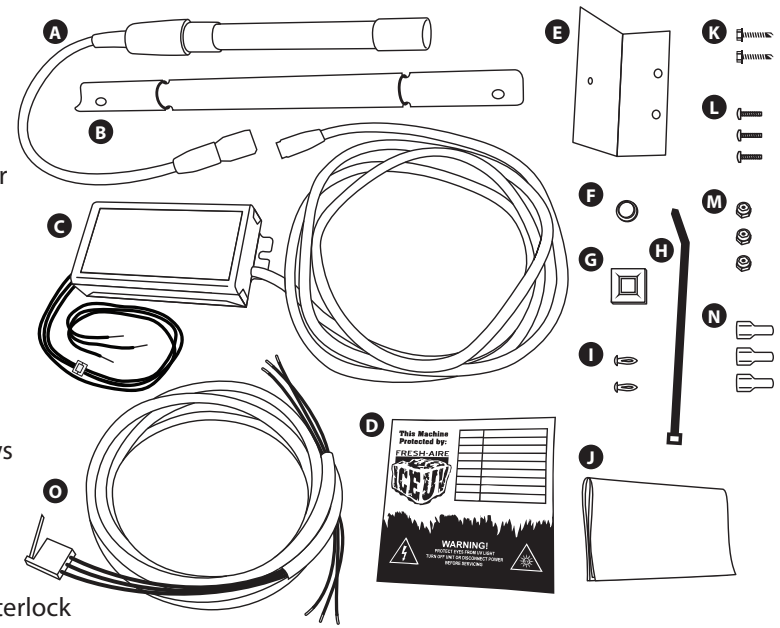

IMPORTANT!

- Only qualified technicians should install this product
- Install in accordance with relevant building codes
- Read instructions carefully including safety warnings

© 2014 Fresh-Aire UV
TUV-ICE-MAN 7.24.14



WARNING
PROTECT EYES FROM UV LIGHT
TURN OFF UNIT OR DISCONNECT
BEFORE SERVICING



1 Determine UV Lamp Mounting Location

There are many different ice making machines so there is no single "right" Ice UV mounting location. To determine the best location for your ice maker start by looking for areas of mold growth and choose a position for the UV lamp that will provide maximum exposure to that area. Consider using Ice UV Dual (DT) for 600 lb. or larger ice makers.

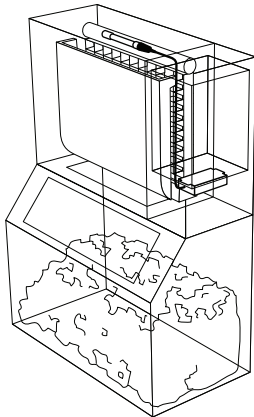

Mount on lid between
evaporator and deflector

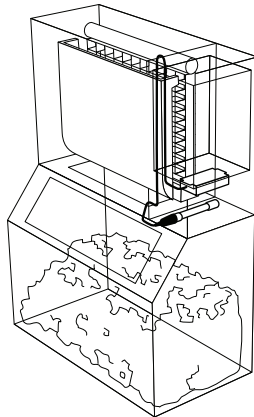

*Mount over ice collection bin
(good second Ice UV lamp location)

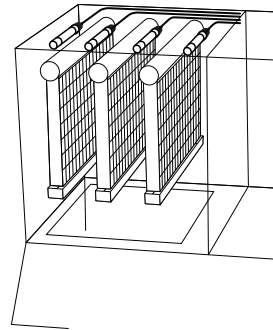

Install multiple Ice UV kits (combine
single and dual as needed) into larger
ice makers for complete coverage

***Important!** use with optional interlock
switch to prevent UVC exposure

2 Mount UV Lamp

After the mounting location is determined the UV lamp(s) can be mounted. First remove the metal shield then mount the shield using self-tapping screws.

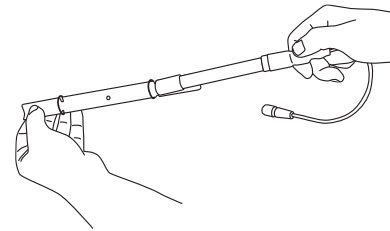

1. Remove UV lamp from shield

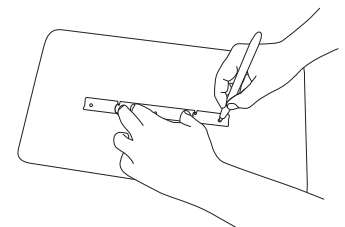

2. Use shield to mark screw holes

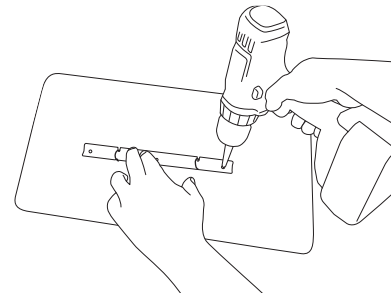

3. Mount shield with self-tapping screws

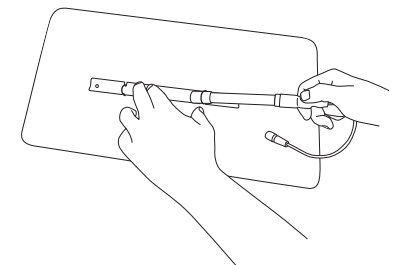

4. Replace lamp onto shield

3 Power Supply Installation

Mount the power supply in a suitable location inside the ice machine. Whenever possible avoid drilling holes by passing wires over interior partitions or through refrigerant pass-through areas. Use the wiring diagram below to connect to 120-277 VAC power. Use zip-ties to dress cables.

2. Wiring Diagram

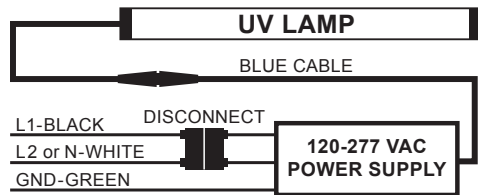

IMPORTANT!

Mount power supply & wires away from control board & sensors to prevent interference

1. Power Supply Mounting

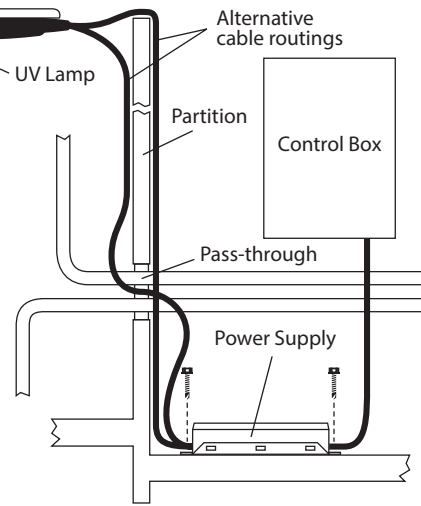

IMPORTANT!

Connect to constant power. Do not cycle UV light on and off. Cycling will reduce the life of the UV lamp and limit effectiveness.

6 Protective Adhesive Vinyl Film

In most cases the UV-C light from Ice UV is not strong enough to damage the plastics inside the ice machine but some discoloring may occur. This can be prevented by using the protective adhesive vinyl film provided.

1. Areas closest to the UV light will be the most prone to discoloration. Cut the vinyl to fit the area of concern.
2. Remove the adhesive backing and press into place.

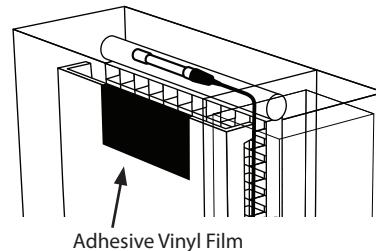

7 Sight Glass Installation

The sight glass indicates that the UV light is working to prevent accidental exposure.

1. Find a suitable location on the outside of the ice machine near the UV Lamp installation and drill a 1/2" hole.
2. Press the sight glass into hole.
3. Turn on the power and use the sight glass to confirm that the UV Lamp is operating.



4 UV Lamp Connection

1. When all the other components are properly installed connect the UV Lamp cable to the Power supply cable.
2. Make sure the flanges are aligned and then push the connectors firmly together. A tight connection ensures a proper water-resistant seal.

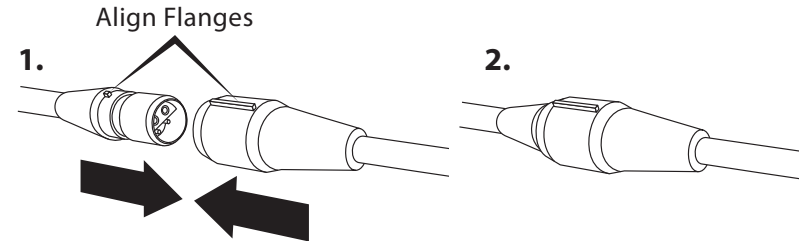

5 Lamp Replacement

The germicidal UV lamp in ICE UV® needs to be replaced every 2 years. Note: UV lamps will continue to emit visible light but lose germicidal effectiveness over time.

Replace UV lamp with TUVL-ICE

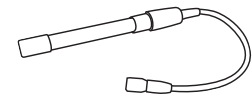

Note: Use of replacement UV lamps other than Fresh-Aire UV® voids warranty.

Caution: UV lamps contain small amounts of mercury - dispose of lamps in accordance with local environmental regulations. For more information visit www.lamprecycle.org

Manufacturer's Warranty:

This warranty supersedes and replaces any warranty statements orally made by the Sales Person, Distributor or Dealer or contained in the written instructions or other Brochures or informational documents in relation to this product. This warranty gives you specific legal rights, and you may also have other rights which vary from State to State.

What Does This Warranty Cover? This lifetime limited manufacturer warranty covers any defects or malfunctions in material and workmanship under the normal use and service when operated and maintained in strict accordance with manufacturer's instructions for the Lifetime of the equipment.

How Long Does The Coverage Last? 1) Fresh-Aire APCO Power Supply: For as long as you own the real property where the product is installed. 2) TUVL-ICE Series Ultraviolet Lamp is warranted for germicidal output for two (2) years from the date of installation. This warranty is not transferable.

What Will Triatomic Environmental, Inc. Do? Triatomic Environmental, Inc. will replace any defective or malfunctioning part at no charge. You must pay any labor charges and shipping charges of defective product to our warranty department.

What Does This Warranty Not Cover? THIS PRODUCT IS NOT INTENDED TO BE PURCHASED AND INSTALLED BY UNLICENSED HVAC OR ELECTRICAL CONTRACTORS. This warranty does not cover products or parts purchased from any source other than licensed HVAC or electrical contractors. This warranty does not cover parts installed by unlicensed HVAC or electrical contractors. This warranty does not cover parts damaged as a result of misuse, abuse, or any use other than its intended use, accident, acts of god, neglect, or from improper operation, maintenance, installation, modification or adjustments. Triatomic Environmental, Inc. shall have no responsibility for charges incurred by the customer for installation or removal of warranted items.

This warranty does not cover parts or equipment used with the Fresh-Aire UV system that are not manufactured by Triatomic Environmental, Inc.

**This warranty shall be void if UV lamps from manufacturer's other than Triatomic Environmental, Inc. are used with this equipment.

Consequential and incidental damages are not recoverable under this warranty. Manufacturer assumes no liability for any harm, which may occur as a result of the use of the equipment herein and shall not be liable for consequential or any other damages whether or not caused by manufacturer's negligence or resulting from any express or implied warranty or breach thereof. Consequential damages for the purpose of this warranty shall include, but not be limited to, loss of use, income or profit, or loss of or damages to property or injury or death to persons or animals occasioned by or arising out of operation, use, the operation, installation, repair or replacement of the equipment or otherwise. Some states do not allow the exclusion or limitation of incidental or consequential damages, so the above limitation or exclusion may not apply to you.

There are no Warranties which extend beyond the description of the face hereof.

How Do You Get Service? In order to be eligible for service under this warranty you MUST return the warranty registration card or register online at www.freshaireuv.com. If something is wrong with your product, call your installing contractor to receive a Return Merchandise Authorization (RMA) and instructions for returning the product to a licensed distributor in your area or the manufacturer.

Once the product is returned, we will inspect your product and contact you within 10 business days of our receipt of the product to give the results of our inspection. If we determine that the product is covered under this warranty, we will ship to you at no additional cost a replacement part. Replacement parts may be refurbished. If we determine that the product is not covered under this warranty, or that this warranty is void, the product will be returned to you COD. There is no charge for inspection.

How Does State Law Apply? This warranty gives you specific legal rights, and you may also have other rights which vary from state to state.